

50 TESTS

**TIME FOR
ENGLISH**



STUDENT'S BOOK

PRIMARY ONE
Second Term

Edited by:
Mr . MOHAMED RAGAB RAGAB









Join Us On The Following Group:

**Teachers of English All
Over the World**

Primary - Preparatory - Secondary

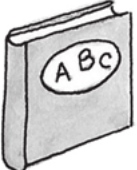
Unit 6 test 1

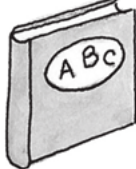



1 – read and circle the correct picture :

kite			
moon			
monkey			



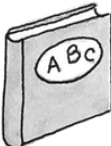

2 – Match

<p>M N B V</p>	<p>v b n m</p>
----------------------------	----------------------------



3 – match

<p>A</p>	<p>B</p>	
<p>1 – moon 2 – monkey 3 – book 4 – lizard</p>	 	  

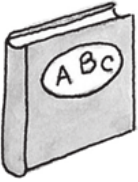

4 – circle :

				
Lemon	Moon	Pick up your book	Pen	bag
Lizard	monkey	Put down your book	Pencil	Book

5- write :

		
.....

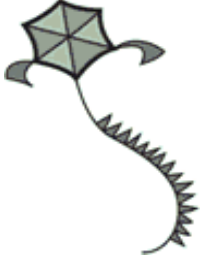
6 – complete :

		
k...te	...eaf	Kin...





7 – copy :

We love our country .

.....

Unit 6 test 2





1 – read and circle the correct picture :

pencil			
Open your bag			
leaf			





2 – Match

<p>C X Z L</p>	<p>I Z X C</p>
----------------------------	----------------------------

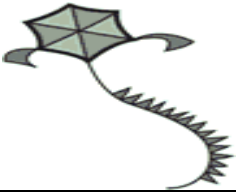

3 – match

A	B
<p>1 – pen 2 – king 3 – lemon 4 – key</p>	    



4 – circle :

				
key	King	Moon	Pick up your book	Bag
Kite	car	monkey	Put down your book	Book

5- write :

		
.....

6 – complete :

		
Monke.....	li.....ardey









7 – copy :

Pick up your book .

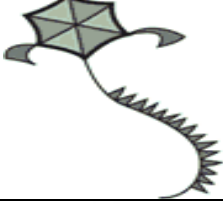
.....

Unit 6 test 3





1 – read and circle the correct picture :

Lemon			
Kite			
Mouse			





2 – Match

<p>K J H G</p>	<p>g h j k</p>
----------------------------	----------------------------



3 – match

A	B	
<p>1 – open your bag 2 – bag 3 – lizard 4 – leaf</p>	 	  



4 – circle :

				
King	Mouse	Moon	Pick up your book	Pen
Key	Moon	Book	Put down your book	Book

5- write :

		
.....

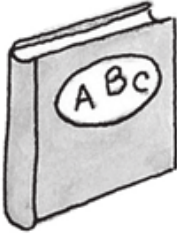
6 – complete :

		
Pen....il	Bo....kag







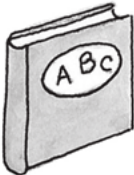

7 – copy :

Put down your book .

.....

Unit 6 test 4

1 – read and circle the correct picture :

Book			
Pencil			
Lizard			



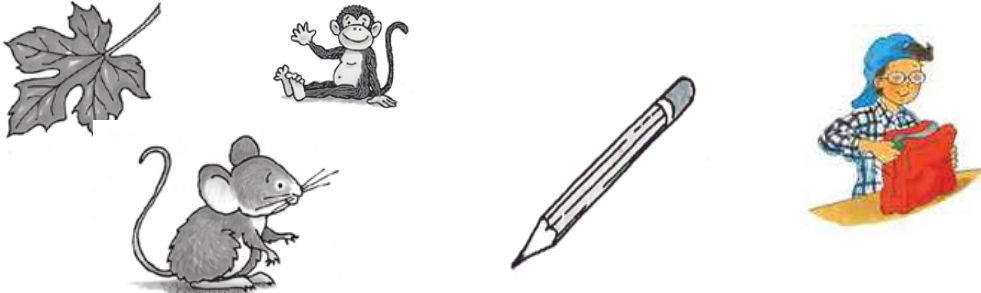

2 – Match

<p>H G F D</p>	<p>d f g h</p>
----------------------------	----------------------------



3 – match

A	B
<p>1 – pencil 2 – mouse 3 – monkey 4 – leaf</p>	

4 – circle :

				
Mouse	Open your bag	Pen	Bag	Moon
Moon	Close your bag	Pencil	Book	Monkey

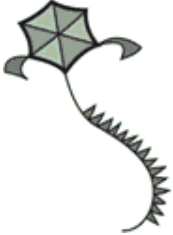
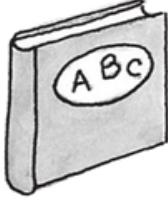
5- write :

		
.....

6 – complete :

		
....encil	Moo.....	Ki....g









7 – copy :

Open your bag.

.....

Unit 6 test 5

1 – read and circle the correct picture :

Close your bag			
Key			
Pick up your book			



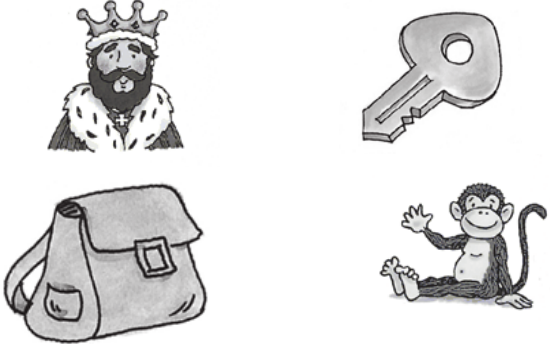

2 – Match

<p>F D S A</p>	<p>a s d f</p>
----------------------------	----------------------------

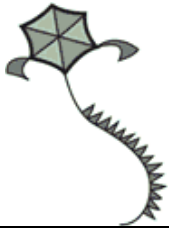

3 – match

<p>A</p>	<p>B</p>	
<p>1 – moon 2 – king 3 – key 4 - monkey</p>		



4 – circle :

				
Leaf	Key	Key	Moon	Book
Lizard	Kite	Kite	Monkey	Bag

5- write :

		
.....

6 – complete :

		
...emon	Lea.....	k.....ng









7 – copy :

Close your bag .

.....

Unit 6 test 6

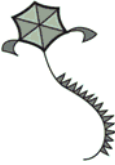

1 – read and circle the correct picture :

Close your bag			
King			
Lemon			





2 – Match

<p>P O I U</p>	<p>u i o p</p>
----------------------------	----------------------------



3 – match

<h3>A</h3>	<h3>B</h3>		
<p>1 – close your bag 2 – kite 3 – monkey 4 – open your bag</p>			

4 – circle :

				
Mouse	Pick up your book	Pick up your book	Bag	Monkey
Moon	Put down your book	Put down your book	Book	Moon

5- write :

		
.....

6 – complete :

		
cl...se	Kin.....pen









7 – copy :

You can t stop me

.....

Unit 6 test 7

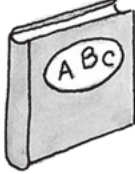
1 – read and circle the correct picture :

King			
Bag			
Put down your book			





2 – Match

<p>Y T R E</p>	<p>e r t y</p>
----------------------------	----------------------------

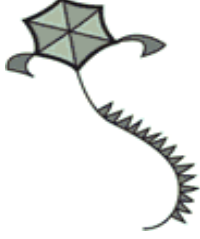

3 – match

<p>A</p>	<p>B</p>
<p>1 – pen 2 – key 3 – moon 4 – monkey</p>	



4 – circle :

				
Leaf	Lemon	Key	Lemon	Key
Lizard	Moon	Kite	Leaf	King

5- write :

		
.....

6 – complete :

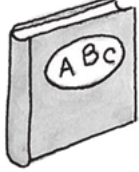
		
...en	Penci.....	Bo....k









7 – copy :

We will appear soon.

.....

Unit 6 test 8





1 – read and circle the correct picture :

Moon			
Pick up your book			
Monkey			





2 – Match

<p>W Q Z X</p>	<p>x z q w</p>
----------------------------	----------------------------

3 – match

A	B		
<p>1 – pick up your book 2 – moon 3 – lizard 4 – bag</p>		 	 

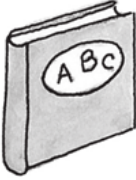
4 – circle :

				
Lemon	Mouse	Open	Book	Bag
Leaf	Monkey	Close	Bag	Bag

5- write :

		
.....

6 – complete :

		
Kin....ey	Mo...key









7 – copy :

This is what we want

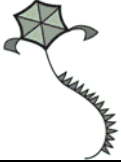
.....

Unit 6 test 9

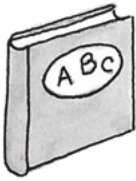
1 – read and circle the correct picture :

Leaf			
Lizard			
Key			



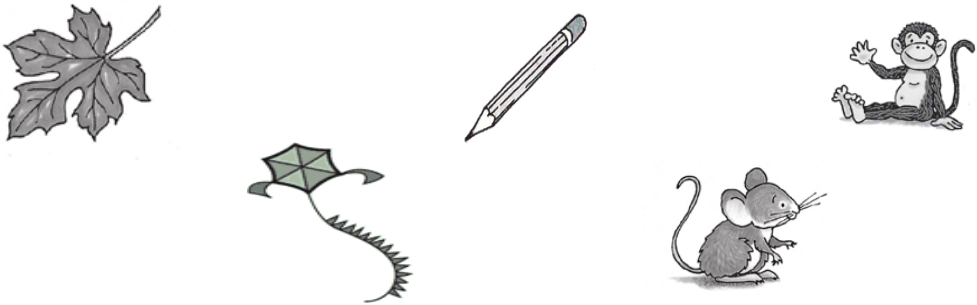

2 – Match

C	n
V	b
B	v
N	c

3 – match

A	B
<p>1 – pencil</p> <p>2 – kite</p> <p>3 – mouse</p> <p>4 – monkey</p>	



4 – circle :

				
Moon	Lemon	Put	Pen	Bag
monkey	Lizard	Pick up	Pencil	Book

5- write :

		
.....

6 – complete :

		
Ba.....	p....t	Moo.....









7 – copy :

We wont stop.

.....

Unit 6 test 10

1 – read and circle the correct picture :

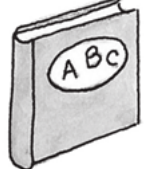

Moon			
Pen			
book			

2 – Match

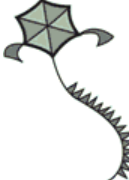

M	j
L	k
K	l
J	m

3 – match

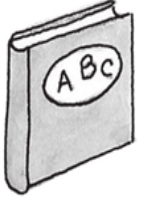
A	B
1 – bag 2 – key 3 – lizard 4 – monkey	

				
Lemon	Key	King	Kite	Bag
Leaf	Kite	Kite	King	Book

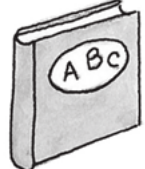
5- write :

		
.....

6 – complete :

		
Mous.....	Lizar.....	Kit.....









7 – copy :

This is the beginning .

.....

Unit 7 test 1

1 – read and circle the correct picture :

Orange			
Sing			
Shout			

2 – Match

<p>M N B V</p>	<p>v b n m</p>
----------------------------	----------------------------



3 – Match :

A	B		
<p>One Two Three four</p>	<p>1 2</p>	<p>5</p>	<p>4 3</p>



4 – circle :

1	4	5	3	2
One	Three	Six	Two	One
Two	Four	Five	Three	Two

5 – complete :

	3	
s....ng	Thre.....	...lap

6 – write :

	2	
.....

7 – copy :

We are mysterious .

.....

Unit 7 test 2

1 – read and circle the correct picture :

five		5	2
Four	1	3	4
Ten	8	9	10





2 – Match

C	I
X	Z
Z	X
L	C



3 – Match :

A	B
Puppy Necklace Nine Eight	<div style="display: flex; align-items: center; justify-content: space-around;"> <div style="text-align: center;"> <p>9</p>  </div> <div style="text-align: center;">  <p>8</p> </div> </div> <p style="text-align: right; font-size: 2em;">10</p>

4 – circle :

5				
Four	Sing	Ox	Office	Sing
Five	Sing	Orange	Orange	Shout

5 – complete :

	6	
.....ffice	Si....	Ora...ge

6 – write :

	5	
.....

7 – copy :

We will continue to the end .

.....

Unit 7 test 3

1 – read and circle the correct picture :

One	1	2	10
Nine	7	9	6
Three	4	3	5



2 – Match

K	g
J	h
H	j
G	k



3 – Match :

A	B
Six	6
Seven	10
Eight	7
Nine	8
	9



4 – circle :

	4		5	
Shout	Three	Orange	Four	Nest
Sing	Four	Office	Five	Nine

5 – complete :

	9	
Nec....lace	Ni....e	Cl.....

6 – write :

	7	
.....









7 – copy :

No retreat no surrender .

.....

Unit 7 test 4





1 – read and circle the correct picture :

Office			
Pen			
Necklace			



2 – Match

<p>F D S A</p>	<p>a s d f</p>
----------------------------	----------------------------



3 – Match :

A	B
<p>Orange Pen Puppy nest</p>	    



4 – circle :

10		8		
Ten	Sing	Seven	Pen	Sing
Nine	Shout	Eight	puppy	Shout

5 – complete :

	10	
Popcor.....	Te.....	..en

6 – write :

	2	
.....





7 – copy :

We have million ideas .

.....

Unit 7 test 5



1 – read and circle the correct picture :

Two		2	
Orange	5		
Popcorn		3	4



2 – Match

P O I U	u i o p
------------------	------------------



3 – Match :

A	B
Pen Nest Orange Seven	   4 7



4 – circle :

7		6		
Six	Orange	Six	Puppy	Sing
Seven	Office	Seven	Popcorn	Shout

5 – complete :

	4	
Nes.....	Fou.....	Pup.....y

6 – write :

	10	
.....



7 – copy :

Expect us .

.....

Unit 7 test 6



1 – read and circle the correct picture :

Nine	8	9	10
Laugh			
Ten	9	10	8



2 – Match

Y T R E	e r t y
------------------	------------------

3 – Match :

A	B
Necklace Three Office puppy	  
	3 4



4 – circle :

	9		8	
Orange	Nine	Pen	Seven	Nest
Office	Eight	Popcorn	Eight	Necklace

5 – complete :

	6	
Sho.....t	Si.....	Cl.....

6 – write :

	1	
.....







7 – copy :

We never forget , we never forgive .

.....

Unit 7 test 7



1 – read and circle the correct picture :

Shout			
Popcorn			
Seven	5	7	6



2 – Match

W	x
Q	z
Z	q
X	w



3 – Match :

A	B
Ten Eight Clap Sing	   8 10

4 – circle :

	9		5	
Popcorn	Six	Pen	Four	Pen
Puppy	Nine	Pencil	Five	puppy

5 – complete :

	7	
Oran.....e	Seve.....	Off.....ce

6 – write :

	5	
.....

7 – copy :

To be the best you need the best .

.....

Unit 7 test 8



1 – read and circle the correct picture :

Clap			
Puppy			
Nest			



2 – Match

C V B N	n b v c
------------------	------------------

3 – Match :

A	B
Three Two Orange Pen	  3  2



4 – circle :

	10		9	
Office	Ten	Nest	Eight	Nest
Orange	Eight	Necklace	Nine	necklace

5 – complete :

		
Neckl.....ce	Cla.....en

6 – write :

	8	
.....



7 – copy :

We have targets ,we have policy .

.....

Unit 7 test 9



1 – read and circle the correct picture :

Five	5	6	7
Orange			
Nine	8	9	10

2 – Match

M	j
L	k
K	l
J	m

3 – Match :

A	B
Nest Pen Seven Nine	   7 9



4 – circle :

	8		7	
Shout	Eight	Shout	Six	Orange
Laugh	Seven	Sing	Seven	office

5 – complete :

		
.....est	Sin.....	Pupp.....

6 – write :

	9	
.....

7 – copy :

Whatever happens we will continue .

.....

Unit 7 test 10

1 – read and circle the correct picture :

Shout			
Clap			
Sing			

2 – Match

<p>H G F D</p>	<p>d f g h</p>
----------------------------	----------------------------



3 – Match :

A	B		
<p>Eight Nine Popcorn Sing</p>	 <p>8</p>	 <p>9</p>	



4 – circle :

	9		10	
Sing	Eight	Clap	Nine	Nest
shout	Nine	Sing	Ten	necklace

5 – complete :

	8	
Shou.....	Eigh.....	Popc.....rn

6 – write :

	7	
.....









7 – copy :

We are stubborn like oxen .

.....

Unit 8 test 1



1 – read and circle the correct picture :

Orange			
Meat			
Cut the meat			



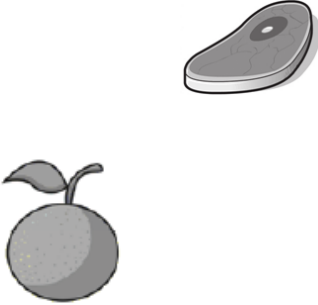

2 – Match

<p>M N B V</p>	<p>v b n m</p>
----------------------------	----------------------------

3 – match :

A	B		
<p>1 – popcorn 2 – rice 3 – orange 4 – meat</p>			



4 – circle :

				
Cut	Cut	Pour	Rice	Pour
Eat	Eat	Drink	Salad	Drink

5 – complete :

		
s.....n	Necklac.....rink

6 – write :

		
.....

7 – copy :

Stop me , if you can.

.....

Unit 8 test 2





1 – read and circle the correct picture :

Sea			
Queen			
Sailboat			





2 – Match

<p>C X Z L</p>	<p>I Z X C</p>
----------------------------	----------------------------



3 – match :

<p>A</p> <p>1 – cut the meat 2 – pour the juice 3 – drink the juice 4 - rainbow</p>	<p>B</p>     
--	---

4 – circle :

				
Meat	Cut	Eat	Pour	Pour
Bread	Eat	Cut	Drink	Drink

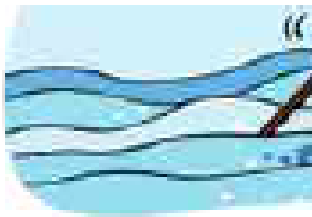
5 – complete :

		
Se.....eat	Rabb....t

6 – write :

		
.....









7 – copy :

The world is unfair .

.....

Unit 8 test 3





1 – read and circle the correct picture :

<p>Pour the juice</p>			
<p>Eat the meat</p>			
<p>Necklace</p>			





2 – Match

<p>K J H G</p>	<p>g h j k</p>
----------------------------	----------------------------



3 – match :

<p>A</p>	<p>B</p>			
<p>1 – nest 2 – sailboat 3 – sun 4 – rabbit</p>				
				



4 – circle :

				
Sun	Queen	Sea	Rabbit	Sea
Sailboat	Question	Sun	Ruler	Sun

5 – complete :

		
Mea.....	Pe.....our

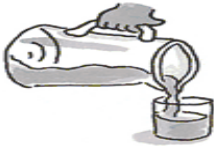
6 – write :

		
.....









7 – copy :

I will take what I want .

.....

Unit 8 test 4

1 – read and circle the correct picture :

puppy			
Rainbow			
Eat the meat			



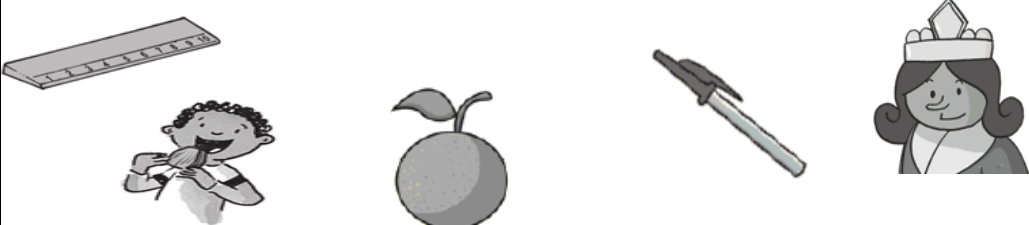

2 – Match

<p>F D S A</p>	<p>a s d f</p>
----------------------------	----------------------------



3 – match :

A	B
<p>1 – ruler 2 – pen 3 – queen 4 – eat the meat</p>	



4 – circle :

				
Rice	Bread	Ruler	Sea	Ox
Salad	Salad	Rainbow	Sun	Orange

5 – complete :

		
Questio.....	Offi.....e	Rai.....bow

6 – write :

		
.....









7 – copy :

We look forward to being modern .

.....

Unit 8 test 5





1 – read and circle the correct picture :

Bread			
Rice			
Rabbit			





2 – Match

<p>P O I U</p>	<p>u i o p</p>
----------------------------	----------------------------



3 – match :

A	B		
<p>1 – meat 2 – rice 3 – salad 4- bread</p>	    		



4 – circle :

				
Rice	Salad	Eat	Sea	Queen
Bread	Bread	Drink	Sailboat	Question

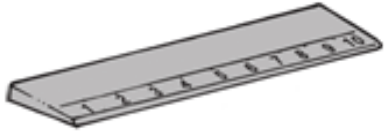
5 – complete :

		
Qu.....en	Ora.....geuler

6 – write :

		
.....









7 – copy :

I like meat .

.....

Unit 8 test 6





1 – read and circle the correct picture :

<p>Pour the juice</p>			
<p>Drink the juice</p>			
<p>Nest</p>			





2 – Match

<p>Y T R E</p>	<p>e r t y</p>
----------------------------	----------------------------

3 – match :

A	B	
<p>1 – sea 2 – rabbit 3 – sun 4 – queen</p>		  
		



4 – circle :

				
Clap	Sing	Orange	Pen	Nest
Sing	Shout	Office	Pencil	Necklace

5 – complete :

		
e....t	s.....ng	Sail.....oat

6 – write :

		
.....

7 – copy :

She cuts the meat .

.....

Unit 8 test 7





1 – read and circle the correct picture :

Rainbow			
Shout			
Sing			



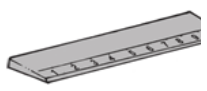

2 – Match

<p>W Q Z X</p>	<p>x z q w</p>
----------------------------	----------------------------



3 – match :

A	B		
<p>1 – ruler 2 – sea 3 – orange 4 - question mark</p>			  <p style="text-align: center; font-size: 2em; font-weight: bold;">?</p>



4 – circle :

				
Salad	Sea	Drink	Rabbit	Sun
Rice	Sun	Eat	Ruler	Sea

5 – complete :

		
Cu.....ffice	Brea.....

6 – write :

		
.....









7 – copy :

He pours the juice .

.....

Unit 8 test 8





1 – read and circle the correct picture :

Sailboat			
Sun			
Pour the juice			





2 – Match

<p>C V B N</p>	<p>n b v c</p>
----------------------------	----------------------------

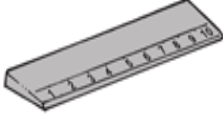

3 – match :

A	B		
<p>1 – pour the juice 2 – cut the meat 3 – eat the meat 4 – salad</p>			  

4 – circle :

				
Queen	Sun	Sea	Ruler	Queen
Question	Sailboat	Sun	Rabbit	Question

5 – complete :

		
Ri.....e	Nes.....	Sala.....

6 – write :

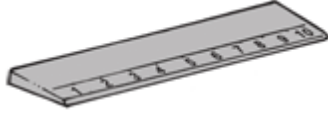
		
.....









7 – copy :

They eat the meat .

.....

Unit 8 test 9





1 – read and circle the correct picture :

<p>Eat the meat</p>			
<p>Salad</p>			
<p>Cut the meat</p>			



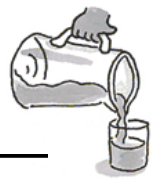

2 – Match

<p>M L K J</p>	<p>j k l m</p>
----------------------------	----------------------------



3 – match :

<p>A</p>	<p>B</p>		
<p>1 – rice 2 – salad 3 – rabbit 4 - sailboat</p>			 



4 – circle :

				
Salad	Bread	Sea	Queen	Ruler
Sun	Salad	Sun	Question	Rabbit

5 – complete :

		
Questio.....alad	Brea.....

6 – write :

		
.....









7 – copy :

They drink the juice .

.....

Unit 8 test 10



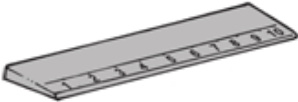

1 – read and circle the correct picture :

Rainbow			
Sea			
Meat			





2 – Match

<p>H G F D</p>	<p>d f g h</p>
----------------------------	----------------------------



3 – match :

A	B		
<p>1 – rabbit 2 – sea 3 – sailboat 4 – queen</p>			
			



4 – circle :

				
Queen	Meat	Rice	Sea	Queen
Question	Bread	Salad	Sailboat	Question

5 – complete :

		
Mea.....	r....ce	Ques.....ion

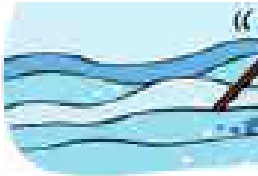
6 – write :

		
.....









7 – copy :

We go to the restaurant .

.....

. Unit 9 test 1





1 – read and circle the correct picture :

Tree			
Umbrella			
Violin			





2 – Match

<p>M</p> <p>N</p> <p>B</p> <p>V</p>	<p>v</p> <p>b</p> <p>n</p> <p>m</p>
-------------------------------------	-------------------------------------



3 – match :

A	B
<p>1 – arms</p> <p>2 – feet</p> <p>3 – head</p> <p>5 - upsidedown</p>	   

4 – circle :

				
Feet	head	Legs	Nest	Meat
Hands	Hand	Hands	Necklace	Bread

5- complete :

		
Va...e	...ead	Fee.....

6 – write :

		
.....









7- copy :

I can brush my hair .

.....

. Unit 9 test 2





1 – read and circle the correct picture :

Arms			
Umbrella			
Meat			





2 – Match

<p>C X Z L</p>	<p>I Z X C</p>
----------------------------	----------------------------



3 – match :

A	B		
<p>1 –legs 2 –table 3 – vase 4 -umbrella</p>			 
			

4 – circle :

				
Comb	Run	Umbrella	Orange	Pen
Brush	upside down	Vest	apple	Puppy

5- complete :

		
Arm.....	Was.....ry

6 – write :

		
.....









7- copy :

We brush our hair .

.....

. Unit 9 test 3



1 – read and circle the correct picture :

<p>upside down</p>			
<p>Table</p>			
<p>Sailboat</p>			





2 – Match

<p>K J H G</p>	<p>g h j k</p>
----------------------------	----------------------------



3 – match :

<p>A</p>	<p>B</p>	
<p>1- nest 2 – umbrella 3 – popcorn 4 –violin</p>		

4 – circle :

				
Legs	Head	Hands	Rabbit	sea
Arms	Legs	Feet	Ruler	Sun

5- complete :

		
Fee.....	c...mb	Vio...in

6 – write :

		
.....





7- copy :

Here a hair on her hair .

.....

. Unit 9 test 4





1 – read and circle the correct picture :

Salad			
Head			
Comb your hair			





2 – Match

F D S A	a s d f
------------------	------------------



3 – match :

A	B
1 – feet 2 – wash your hands 3 – dr your hands 4 – brush your hair	    



4 – circle :

				
Feet	Head	Comb	Upsidedown	Umbrella
Hands	Arms	Brush	Jump	Van

5- complete :

		
Com.....	...ree	Ta...le

6 – write :

		
.....







7- copy :

This dream or that dream is in vain .

.....

. Unit 9 test 5

1 – read and circle the correct picture :

<p>Table</p>			
<p>Vase</p>			
<p>Queen</p>			





2 – Match

<p>P O I U</p>	<p>u i o p</p>
----------------------------	----------------------------

3 – match :

<p>A</p>	<p>B</p>
<p>1 – upsidedown 2 – umbrella 3 –telephone 4 –head</p>	



4 – circle :

				
Tree	Vest	Vase	Bread	Nest
Ten	Violin	Vest	Rice	Necklace

5- complete :

		
Umbr...lla	Telep...one	Va...e

6 – write :

		
.....









7- copy :

You should obey your parets .

.....

. Unit 9 test 6

1 – read and circle the correct picture :

umbrella			
Feet			
Arms			



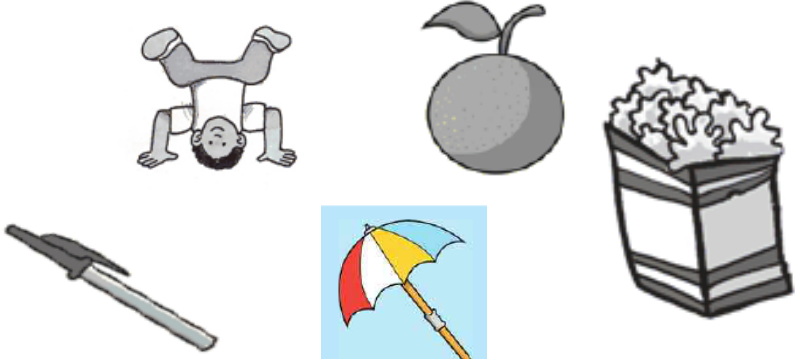

2 – Match

<p>Y T R E</p>	<p>e r t y</p>
----------------------------	----------------------------

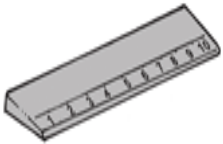

3 – match :

A	B
<p>1 – umbrella 2 – popcorn 3 – orange 4 - upsidedown</p>	



4 – circle :

				
Ruler	Rabbit	Vase	Umbrella	Salad
rabbit	Rainbow	Vest	Van	Rice

5- complete :

		
Fee.....	u....sidedown	Umbr....lla

6 – write :

		
.....

7- copy :

Why can t you help us ?

.....

. Unit 9 test 7

1 – read and circle the correct picture :

necklace			
Upsidedown			
Feet			





2 – Match

W	x
Q	z
Z	q
X	w



3 – match :

A	B
1 – head 2 – hands 3 – vase 4 – comb your hair	    

4 – circle :

				
Feet	Head	Hands	Sea	Sea
Hands	Legs	feet	Sailboat	Sun

5- complete :

		
u....sidedownase	Hea.....

6 – write :

		
.....









7- copy :

Our dear Egypt you are poor , we are poor too , but we will dress you beautifully .

.....

. Unit 9 test 8





1 – read and circle the correct picture :

Table			
Dry your hands			
Feet			



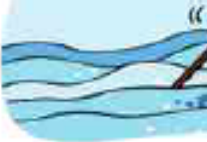

2 – Match

C V B N	n b v c
------------------	------------------



3 – match :

A	B	
1 – head 2 – sea 3 – telephone 4 -sailboat	 	  

4 – circle :

				
Wash	Dry	Umbrella	Comb	Comb
Dry	Wash	Vest	Brush	Brush

5- complete :

		
Teleph.....ne	Umbrell.....eet

6 – write :

		
---	---	---

.....

.....

.....









7- copy :

Dreams are born and dreams are to die .

.....

. Unit 9 test 9





1 – read and circle the correct picture :

Necklace			
Umbrella			
Sun			





2 – Match

<p>M L K J</p>	<p>j k l m</p>
----------------------------	----------------------------



3 – match :

A	B
<p>1 –rainbow 2 –umbrella 3 – hands 4 – wash your hands</p>	    



4 – circle :

				
Hands	Feet	Jump	Apple	Queen
Legs	Hands	Upsidedown	Orange	Question

5- complete :

		
Fee.....	Quee.....rms

6 – write :

		
.....









7- copy :

When will be able ?

.....

. Unit 9 test 10





1 – read and circle the correct picture :

Brush your hair			
Feet			
Legs			





2 – Match

<p>H G F D</p>	<p>d f g h</p>
----------------------------	----------------------------



3 – match :

A	B	
<p>1 – tree 2 – table 3 – violin 4- hands</p>	 	  



4 – circle :

				
Run	Vest	Vase	Table	Violin
Upsidedown	Umbrella	Van	Telephone	Vest

5- complete :

		
Umbre....la	Oran....e	Fe....t

6 – write :

		
.....









7- copy :

We are waiting for dawn .

.....

. Unit 10 test 1





1 – read and circle the correct picture :

Camel			
Lion			
Horse			



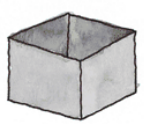

2 – Match

M N B V	v b n m
------------------	------------------



3 – match :

A	B
1 – FOX 2 – WINDOW 3 – WATCH 4 – BOX	    

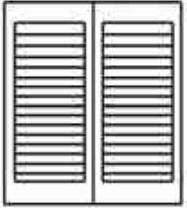

4 – circle :

				
Horse	Car	Dog	Slide	Watch
Cat	Elephant	Camel	Swim	Window

5 – complete :

		
Mo...key	...at	Lio.....

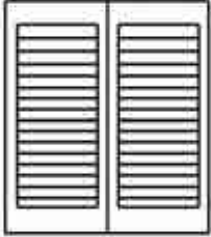
6 – write :

		
.....









7 – copy :

Love death , life loves you .

.....

. Unit 10 test 2

1 – read and circle the correct picture :

Slide			
Fox			
Jump			



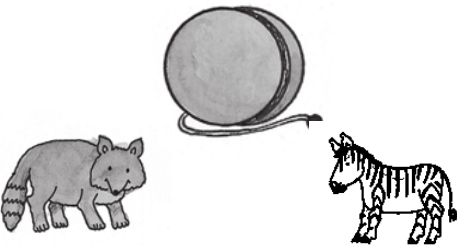

2 – Match

<p>C X Z L</p>	<p>I Z X C</p>
----------------------------	----------------------------

3 – match :

<p>A</p>	<p>B</p>	
<p>1 – sailboat 2 – yoyo 3 – zoo 4 – zebra</p>		

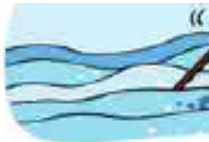

4 – circle :

				
Zoo	Zoo	Sun	Sun	Apple
Zebra	Zebra	sailboat	Sea	Orange

5 – complete :

		
Monke.....	Do.....	Sl...de

6 – write :

		
.....









7 – copy :

Love life ,life hates you .

.....

. Unit 10 test 3

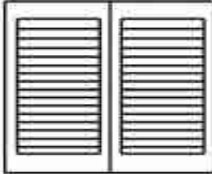



1 – read and circle the correct picture :

Zebra			
Zoo			
Watch			





2 – Match

<p>K J H G</p>	<p>g h j k</p>
----------------------------	----------------------------



3 – match :

A	B
<p>1 – yoyo 2 – whistle 3 – telephone 4 – jump</p>	    

4 – circle :

				
Cat	Fish	Dog	Sun	Sun
Dog	Car	Camel	Sailboat	Sea

5 – complete :

		
Elep.....ant	Sl.....de	Hor.....e

6 – write :

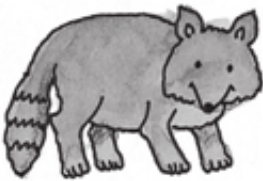
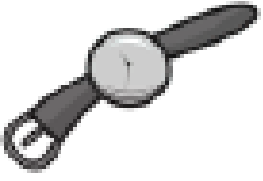
		
.....







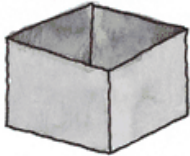

7 – copy :

It is injustice .

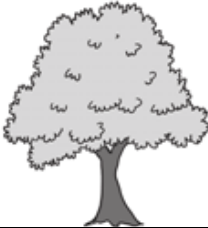
.....

. Unit 10 test 4

1 – read and circle the correct picture :

Tree			
Umbrella			
Lion			



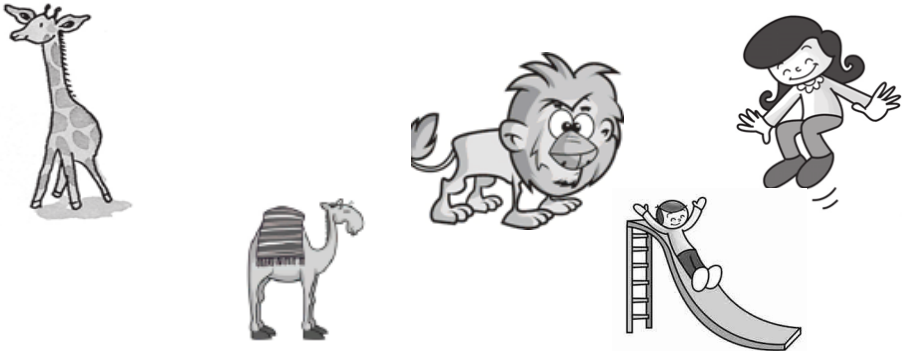

2 – Match

<p>F D S A</p>	<p>a s d f</p>
----------------------------	----------------------------



3 – match :

<p>A</p>	<p>B</p>
<p>1 – giraffe 2 – lion 3 – slide 4 – camel</p>	



4 – circle :

				
Donkey	Dog	Cat	Vase	Nest
Lion	Cat	Dog	Vest	Sea

5 – complete :

		
c.....t	Whi....tle	Giraf....e

6 – write :

		
.....







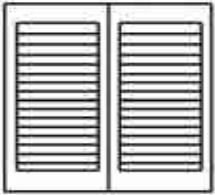

7 – copy :

We are waiting for the smiling hope .

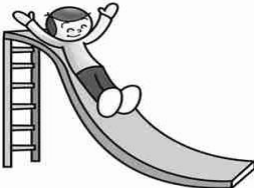
.....

. Unit 10 test 5

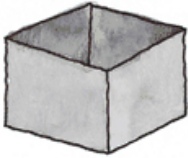



1 – read and circle the correct picture :

Popcorn			
Watch			
Box			





2 – Match

<p>P O I U</p>	<p>u i o p</p>
----------------------------	----------------------------

3 – match :

A	B
<p>1 – cat 2 – dog 3 – fish 4 – monkey</p>	    

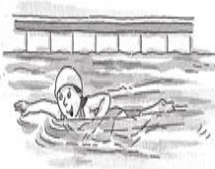

4 – circle :

				
Run	Jump	Swim	Slide	Yoyo
Jump	Run	Book	Zoo	Zoo

5 – complete :

		
Cam.....l	Do.....oo

6 – write :

		
.....







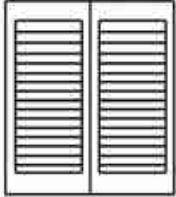

7 – copy :

We are mysterious .

.....

. Unit 10 test 6

1 – read and circle the correct picture :

Window			
Zebra			
Horse			



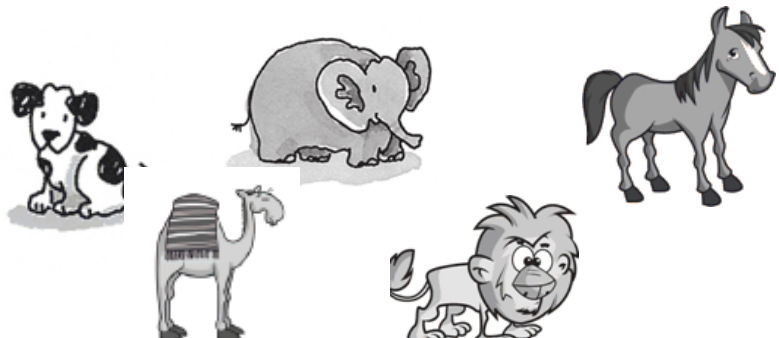

2 – Match

<p>Y T R E</p>	<p>e r t y</p>
----------------------------	----------------------------

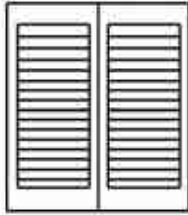

3 – match :

A	B
<p>1 – elephant 2 – dog 3 – lion 4 – horse</p>	



4 – circle :

				
Hen	Cat	Dog	Watch	Sun
Horse	Lion	Cat	Window	Sailboat

5 – complete :

		
j.....mp	Sw.....m	Yoy.....

6 – write :

		
.....









7 – copy :

Up on our arms should the future be built .

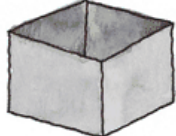
.....

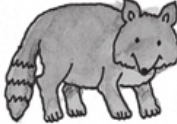
. Unit 10 test 7

1 – read and circle the correct picture :

Fish			
Fox			
Yoyo			



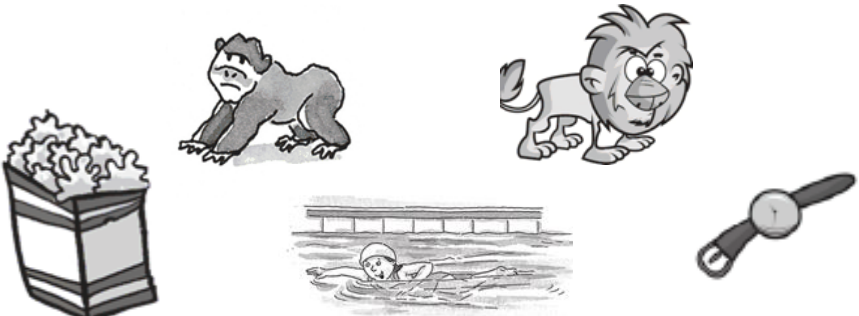

2 – Match

<p>W Q Z X</p>	<p>x z q w</p>
----------------------------	----------------------------

3 – match :

A	B
<p>1 – popcorn 2 – lion 3 – watch 4 – swim</p>	



4 – circle :

				
Slide	Vase	Cat	Fan	Tree
Smile	Violin	Dog	Fish	Table

5 – complete :

		
Ru.....	Jum.....	Sailbo.....t

6 – write :

		
.....







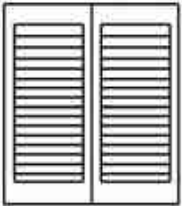

7 – copy :

Tomorrow can not be stopped .

.....

. Unit 10 test 8

1 – read and circle the correct picture :

Slide			
Yoyo			
Elephant			



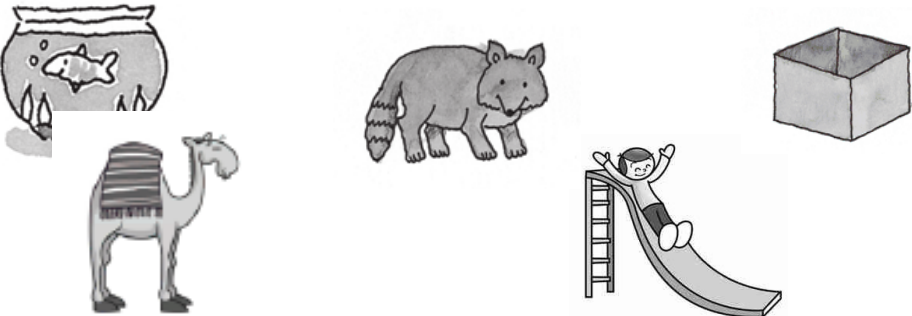

2 – Match

<p>C V B N</p>	<p>n b v c</p>
----------------------------	----------------------------



3 – match :

A	B
<p>1 – fish 2 – camel 3 – box 4 – slide</p>	

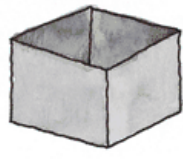

4 – circle :

				
Lion	Monkey	Van	Run	Sea
Cat	Dog	Camel	Upsidedown	Sailboat

5 – complete :

		
f.....sh	b.....x	Tre.....

6 – write :

		
.....









7 – copy :

Kill dreams , stop dreams we can not stop .

.....

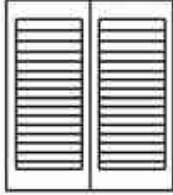
. Unit 10 test 9

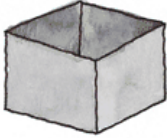



1 – read and circle the correct picture :

Orange			
Window			
Sun			





2 – Match

<p>M L K J</p>	<p>j k l m</p>
----------------------------	----------------------------



3 – match :

A	B
<p>1 – sun 2 – fox 3 – camel 4 – umbrella</p>	<div style="display: flex; justify-content: space-around; align-items: flex-start;"> <div style="text-align: center;">  </div> <div style="text-align: center;">  </div> <div style="text-align: center;">  </div> </div> <div style="display: flex; justify-content: space-around; margin-top: 20px;"> <div style="text-align: center;">  </div> <div style="text-align: center;">  </div> </div>



4 – circle :

				
Run	Swim	Zoo	Zebra	Sun
Jump	Slide	Yoyo	Zoo	Zebra

5 – complete :

		
.....mbrella	Zebr.....atch

6 – write :

		
.....







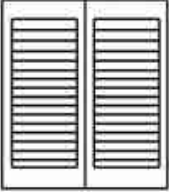

7 – copy :

We will rise up soon .

.....

. Unit 10 test 10



1 – read and circle the correct picture :

Window			
Slide			
Fish			





2 – Match

<p>H G F D</p>	<p>d f g h</p>
----------------------------	----------------------------

3 – match :

A	B
<p>1 – giraffe 2 – slide 3 – lion 4 – zebra</p>	 



4 – circle :

				
Car	Donkey	Zebra	Swim	Zoo
Cat	Do	zoo	Sun	yOyo

5 – complete :

		
Me.....t	Windo.....	f.....x

6 – write :

		
.....

7 – copy :

From this moment you can not stop us .

.....

تمنياتى بالتوفيق للجميع
مستر محمد رجب رجب
كفر الشيخ
مطوبس
٢٠١٧

التضحية --- الاخلاص ----- الشرف ----- عدم الاستسلام

Edited by:
Mr . MOHAMED RAGAB RAGAB

Join Us On The Following Group:

**Teachers of English All
Over the World**

Primary - Preparatory - Secondary